



PRODUCT INFORMATION



McElroy Metal, Inc.



MULTI-RIB



R-PANEL



MULTI-V



MINI-RIB

MULTI-RIB • R-PANEL

MULTI-V • MINI-RIB



CONTENTS

General Information _____	P-1
Multi-Rib, R-Panel, Multi-V, and Mini-Rib Panel Pricing ____	P-2
Multi-Rib and R-Panel Trim _____	P-3
Multi-V Trim _____	P-9
Mini-Rib Trim _____	P-11
Accessories _____	P-12
Note Page _____	P-15



Multi-Rib General Information

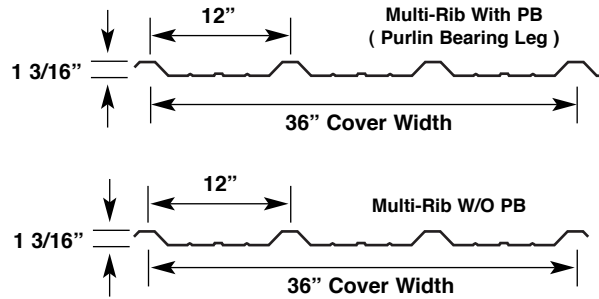
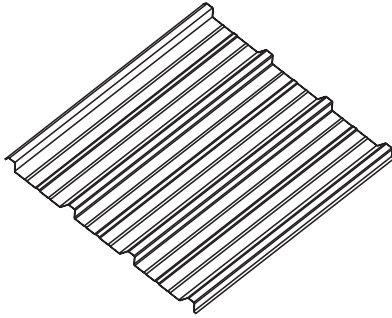

R-Panel General Information

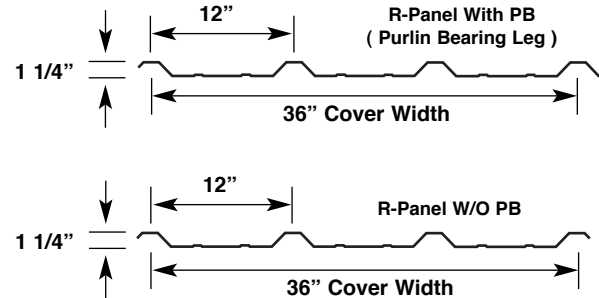
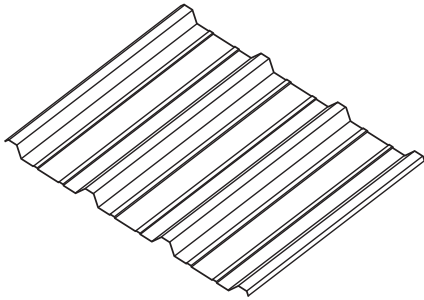

Multi-V General Information

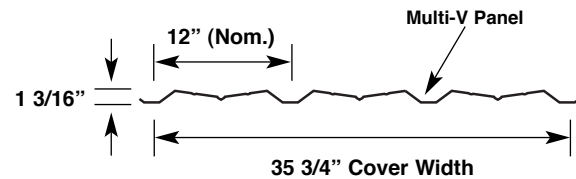
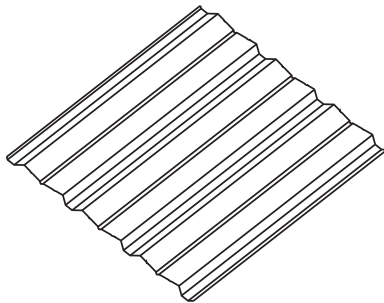

Mini-Rib General Information

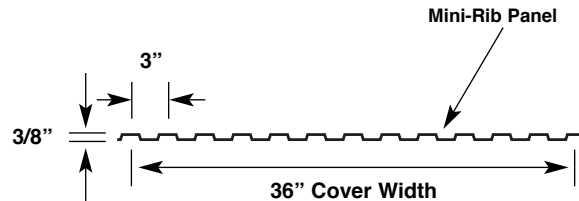
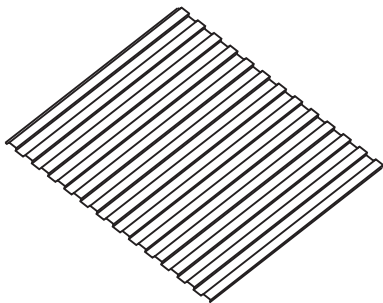

Section Properties

Load Tables and Section Properties for Multi-Rib, R-Panel, Multi-V and Mini-Rib may be found online at www.mcelroymetal.com. Please contact the **McElroy Technical Service Department** at **1-800-950-9082** for additional information.



MULTI-RIB/R-PANEL/MULTI-V/MINI-RIB

PRICING

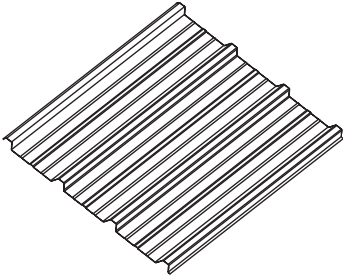
MULTI-RIB		Pricing			
	Gauge	Galvalume Plus	Siliconized Polyester	Kynar 500®	Brandywine Hartford Green
	26 Gauge Multi-Rib				
	24 Gauge Multi-Rib		CALL FOR PRICING		
	NOTES: • Multi-Rib Trim begins on page P-3 of this Price & Product Book.				

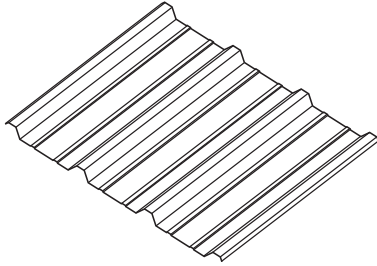
R-PANEL		Pricing			
	Gauge	Galvalume Plus	Siliconized Polyester	Kynar 500®	Brandywine Hartford Green
	26 Gauge R-Panel				
	24 Gauge R-Panel		CALL FOR PRICING		
	NOTES: • R-Panel Trim begins on page P-3 of this Price & Product Book.				

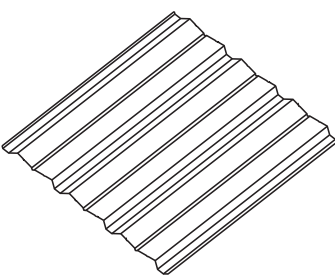
MULTI-V		Pricing			
	Gauge	Galvalume Plus	Siliconized Polyester	Kynar 500®	Brandywine Hartford Green
	26 Gauge Multi-V				
	24 Gauge Multi-V		CALL FOR PRICING		
	NOTES: • To be used as a wall panel only. • Multi-V Trim found on page P-9 and P-10 of this Price & Product Book.				

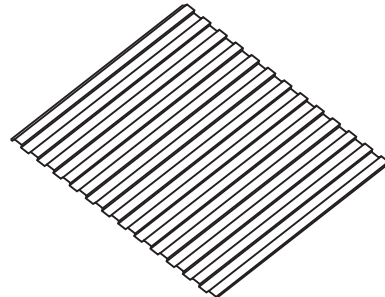
MINI-RIB		Pricing		
	Gauge	Galvalume Plus	Kynar 500®	Brandywine Hartford Green
	29 Gauge Mini-Rib			
	26 Gauge Mini-Rib			
	24 Gauge Mini-Rib			
	NOTES: • To be used as a wall panel only. • Mini-Rib Trim found on page P-11 of this Price & Product Book.			



- NOTES:**
- All prices are FOB McElroy Metal's facilities.
 - For lengths under 3 feet add \$0.75 per piece and over 50 feet add \$1.50 per piece.
 - Invoice pricing is calculated on a per square basis.
 - All prices are subject to change without notice and those prices at time of shipment will apply.
 - Additional cost will apply to the following colors: Brandywine and Hartford Green.
Please contact your McElroy Metal Representative for details.

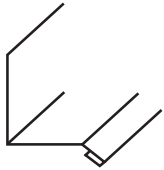
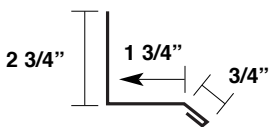
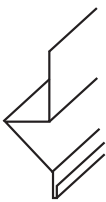
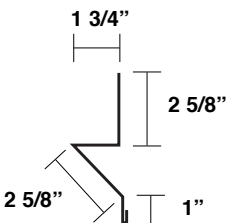
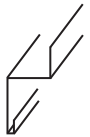
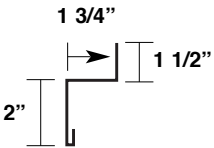
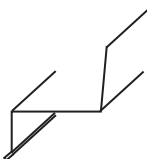
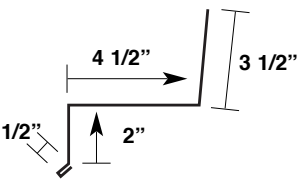
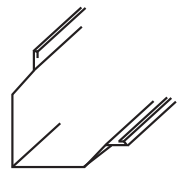
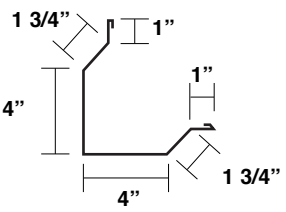
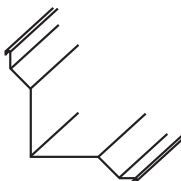
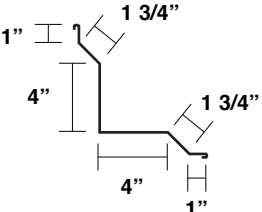

MULTI-RIB / R-PANEL



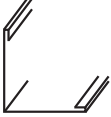
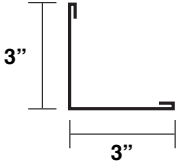
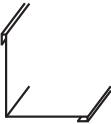
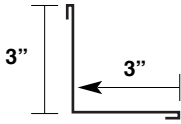
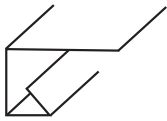
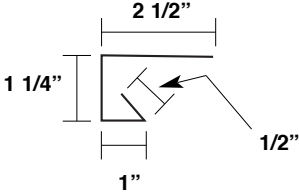
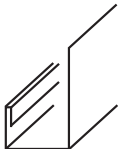
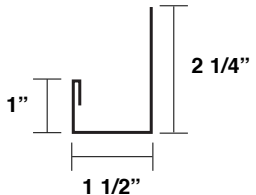
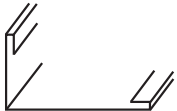
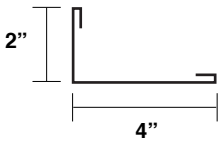

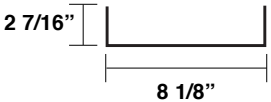
Product	GAUGE	UNIT OF MEASURE	LENGTH	WEIGHT	PRICING		Profiles & Dimensions
					BARE	PAINTED	
	26	EACH	10'-3"	3.80			
	26	EACH	14'-3"	5.32			
Simple Base Trim							
	26	EACH	10'-3"	5.80			
	26	EACH	14'-3"	8.12			
Base Trim							
	26	EACH	10'-3"	3.80			
	26	EACH	14'-3"	5.32			
Zee Flashing							
	26	EACH	10'-3"	7.15			
	26	EACH	14'-3"	10.00			
Masonry Wainscoat							
	26	EACH	10'-3"	9.50			
	26	EACH	14'-3"	13.25			
Outside Corner							
	26	EACH	10'-3"	9.50			
	26	EACH	14'-3"	12.25			
Inside Corner							

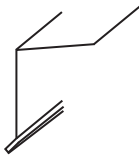
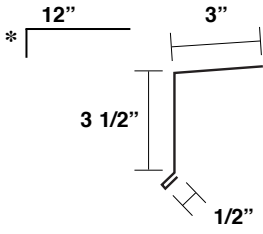
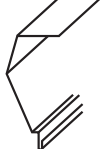
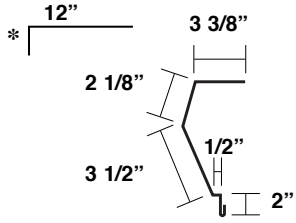
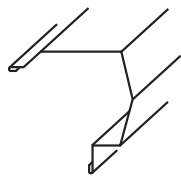
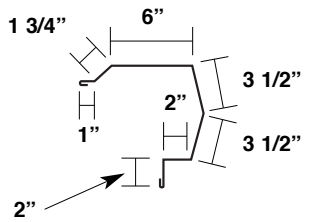
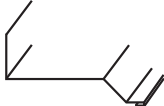
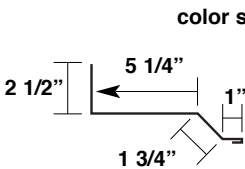

Product	GAUGE	UNIT OF MEASURE	LENGTH	WEIGHT	PRICING		Profiles & Dimensions
					BARE	PAINTED	
	26	EACH	10'-3"	4.65			
	26	EACH	14'-3"	6.58			
Outside Angle Trim							
	26	EACH	10'-3"	4.65			
	26	EACH	14'-3"	6.58			
Inside Angle Trim							
	26	EACH	10'-3"	3.60			
	26	EACH	14'-3"	5.00			
Jamb Trim							
	26	EACH	10'-3"	3.60			
	26	EACH	14'-3"	5.00			
Head Trim							
	26	EACH	7'-1"	3.75			
	26	EACH	8'-1"	4.25			
	26	EACH	9'-1"	4.80			
Mini Jamb-Header Cover							
	26	EACH	10'-3"	8.40			
	26	EACH	14'-3"	11.75			
Jamb-Header Cover							

MULTI-RIB / R-PANEL

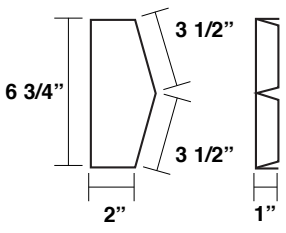
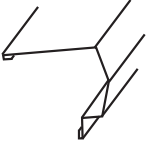
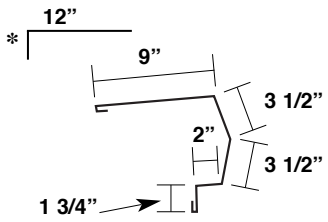

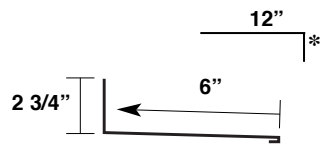
Product	GAUGE	UNIT OF MEASURE	LENGTH	WEIGHT	PRICING		Profiles & Dimensions
					BARE	PAINTED	
	26	EACH	10'-3"	5.25			
	26	EACH	14'-3"	7.42			
Eave Trim* *specify roof pitch							
	26	EACH	10'-3"	7.95			
	26	EACH	14'-3"	13.04			
Sculptured Eave Trim* *specify roof pitch							
	26	EACH	10'-3"	13.75			
	26	EACH	14'-3"	19.32			
	26	EACH	20'-3"	27.15			
Rake Trim							
	26	EACH	10'-3"	7.00			
	26	EACH	14'-3"	9.80			
Rake Tie-In Trim							
	26	EACH	N/A	.35			
Rake Closure							
	26	EACH	10'-3"	13.85			
	26	EACH	14'-3"	19.46			
	26	EACH	20'-3"	27.35			
High Side Eave Flashing* *specify roof pitch							
	26	EACH	10'-3"	5.90			
	26	EACH	14'-3"	8.26			
High Side Tie-In Trim* *specify roof pitch							



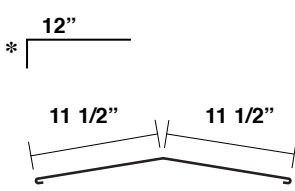
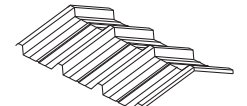
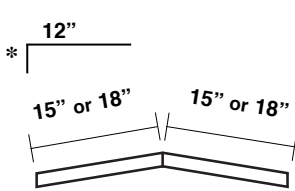
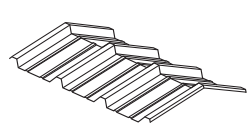
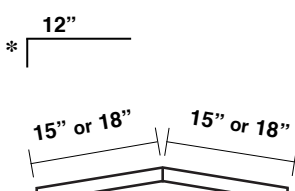
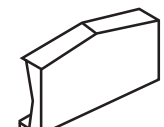
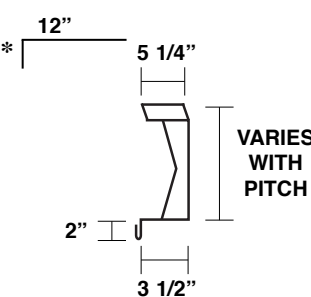
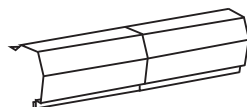
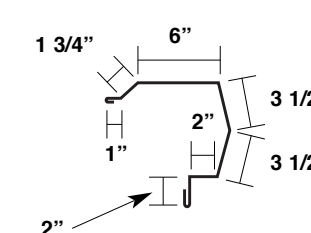
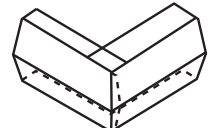
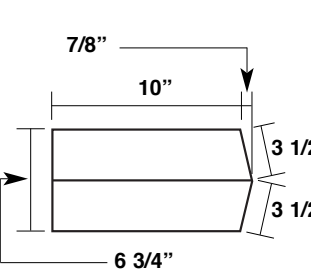

Product	GAUGE	UNIT OF MEASURE	LENGTH	WEIGHT	PRICING		Profiles & Dimensions
					BARE	PAINTED	
 Ridge Cap* *specify roof pitch	26	EACH	10'-3"	15.90			
	26	EACH	14'-3"	22.26			
 Multi-Rib Formed Ridge Cap* *specify roof pitch	26	EACH	30"	6.70			
	26	EACH	36"	8.15			
 R-Panel Formed Ridge Cap* *specify roof pitch	*26	EACH	30"	*6.70			
	26	EACH	36"	8.15			
 Fixed Peak Box* *specify roof pitch	26	EACH	1'-8"	2.40			
 Variable Peak Box	26	EACH	4'-0"	5.40			
 ** Outside Corner Box For Standard Gutter (Right Hand Shown Left Hand Opposite)	26	EACH	N/A	2.30			



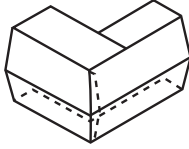
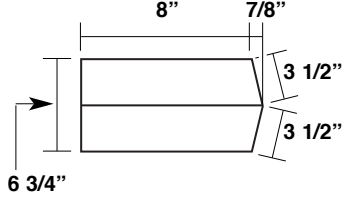
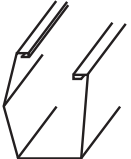
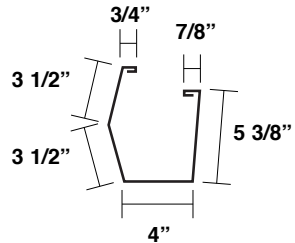
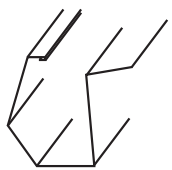
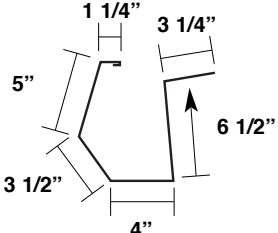

** Snow guards required to prevent damage caused by sliding snow.

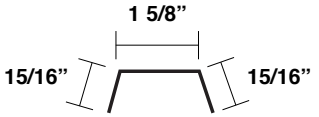
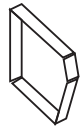
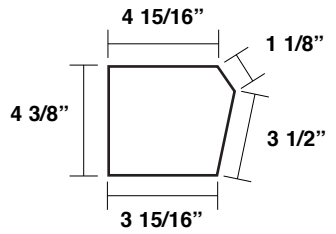
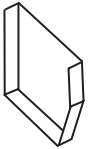
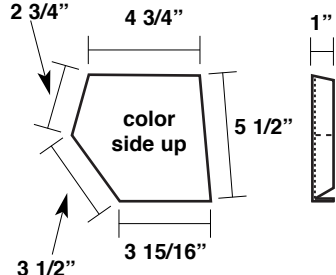
MULTI-RIB / R-PANEL

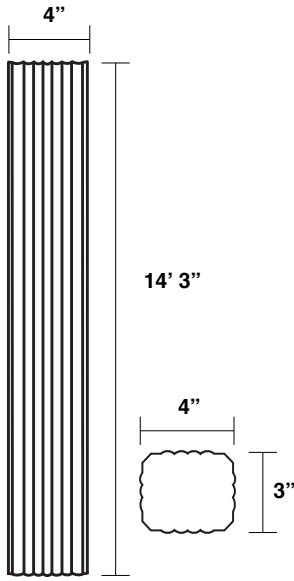
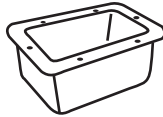
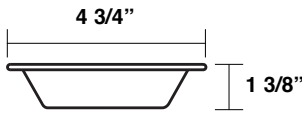

Product	GAUGE	UNIT OF MEASURE	LENGTH	WEIGHT	PRICING		Profiles & Dimensions
					BARE	PAINTED	
 High Side Corner Box (Right Hand Shown Left Hand Opposite)	26	EACH	N/A	2.30			
 ** Standard Gutter	26	EACH	10'-3"	12.20			
	26	EACH	14'-3"	17.08			
	26	EACH	20'-3"	24.10			
					** Snow guards required to prevent damage caused by sliding snow.		
 ** Sculptured Gutter	26	EACH	10'-3"	16.20			
	26	EACH	14'-3"	22.68			
	26	EACH	20'-3"	32.00			
					** Snow guards required to prevent damage caused by sliding snow.		
 Gutter Strap	26	EACH	0'-6"	.18			
 Standard Gutter End Cap (Right Hand Shown Left Hand Opposite)	26	EACH	N/A	.30			
 Sculptured Gutter End Cap (Right Hand Shown Left Hand Opposite)	26	EACH	N/A	.30			

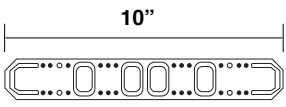
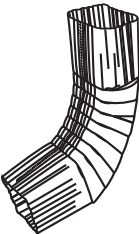
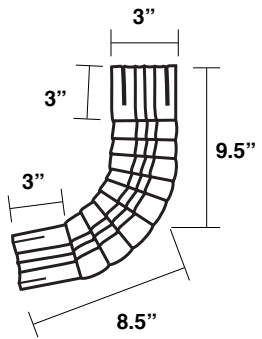

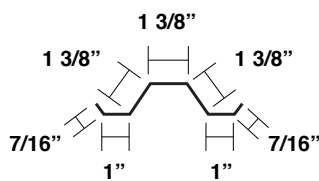
Product	GAUGE	UNIT OF MEASURE	LENGTH	WEIGHT	PRICING		Profiles & Dimensions
					BARE	PAINTED	
 3" x 4" Downspout	26	EACH	14'-3"	15.53	N/A		
 Aluminum Downspout Outlet Box	N/A	EACH	N/A	.10	N/A		
 Downspout Strap	26	EACH	10"	.04			
 3" X 4" Downspout Elbow A-Style	29	EACH	N/A	.50	N/A		
 Skylight Side Trim-UL90	26	EACH	10'-3"	4.55			

MULTI-RIB / R-PANEL



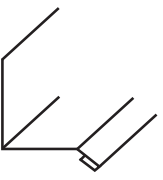
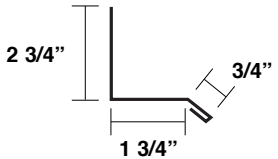
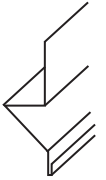
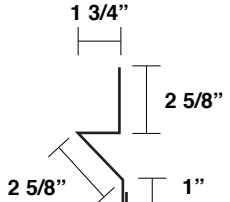
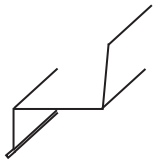
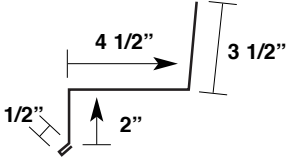
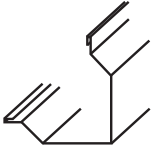
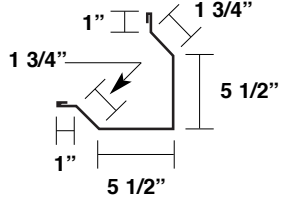
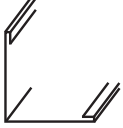
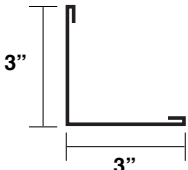

MULTI-V

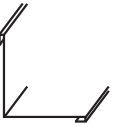
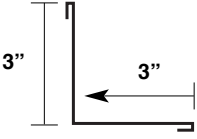
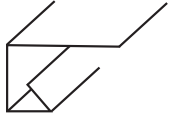
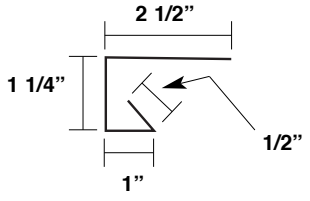
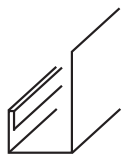
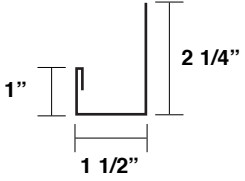
Product	GAUGE	UNIT OF MEASURE	LENGTH	WEIGHT	PRICING		Profiles & Dimensions
					BARE	PAINTED	
	26	EACH	10'-3"	3.80			
	26	EACH	14'-3"	5.32			
Simple Base Trim							
	26	EACH	10'-3"	5.80			
	26	EACH	14'-3"	8.12			
Base Trim							
	26	EACH	10'-3"	7.15			
	26	EACH	14'-3"	10.00			
Masonry Wainscoat							
	26	EACH	10'-3"	10.10			
	26	EACH	14'-3"	14.04			
Outside Corner							
	26	EACH	10'-3"	4.65			
	26	EACH	14'-3"	6.58			
Outside Angle Trim							

Product	GAUGE	UNIT OF MEASURE	LENGTH	WEIGHT	PRICING		Profiles & Dimensions
					BARE	PAINTED	
	26	EACH	10'-3"	4.65			
	26	EACH	14'-3"	6.58			
Inside Angle Trim							
	26	EACH	10'-3"	3.60			
	26	EACH	14'-3"	5.00			
Jamb Trim							
	26	EACH	10'-3"	3.60			
	26	EACH	14'-3"	5.00			
Head Trim							

NOTES:

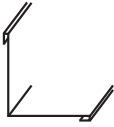
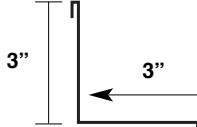

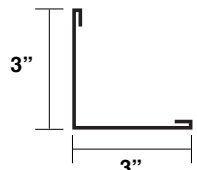







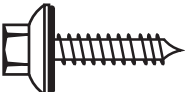

Product	GAUGE	UNIT OF MEASURE	LENGTH	WEIGHT	PRICING		Profiles & Dimensions
					BARE	PAINTED	
	26	EACH	10'-3"	4.65			
	26	EACH	14'-3"	6.58			
Inside Angle Trim							
	26	EACH	10'-3"	4.65			
	26	EACH	14'-3"	6.58			
Outside Angle Trim							

NOTES:



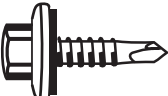
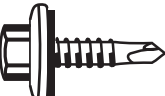









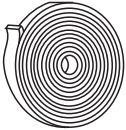
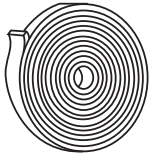

Accessories

Product	GAUGE	UNIT OF MEASURE	LENGTH	WEIGHT	PRICING		Profiles & Dimensions
					BARE	PAINTED	
 1/4 - 14 x 1 1/4" TEK2 ZAC Self-Driller (Part # Varies by Color)	N/A	PER 1000	1 1/4"	27.00/M	PER THOUSAND	PER THOUSAND	
 1/4-14 x 7/8" LAPTEK ZAC Self-Driller (Part # Varies by Color)	N/A	PER 1000	7/8"	24.80/M	PER THOUSAND	PER THOUSAND	
 #14 x 1 1/2" Type AB ZAC (Part # Varies by Color)	N/A	PER 1000	1 1/2"	28.20/M	PER THOUSAND	PER THOUSAND	
 #12 - 14 x 1 1/4" TEK2 HWH w/washer Self-Driller (Part # Varies by Color)	N/A	PER 1000	1 1/4"	15.50/M	PER THOUSAND	PER THOUSAND	
 1/4 - 14 x 7/8" LAPTEK HWH w/washer Self-Driller (Part # Varies by Color)	N/A	PER 1000	7/8"	16.00/M	PER THOUSAND	PER THOUSAND	
 43D Pop Rivet (Part # Varies by Color)	N/A	PER 1000	1/8"	1.30/M	PER THOUSAND		







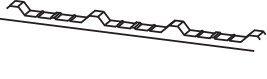

MULTI-RIB/R-PANEL/MULTI-V/MINI-RIB

Accessories

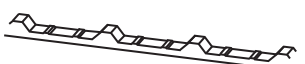
Product	GAUGE	UNIT OF MEASURE	LENGTH	WEIGHT	PRICING PER ITEM	Profiles & Dimensions
 Touch-Up Paint Pen (Part # Varies by Color)	N/A	EACH	N/A	2.5 oz		
 Roll Tape Sealant 1/8" x 1" x 30' Item #: 95345	N/A	EACH	30'	2.39		
 White Urethane Sealant Item #: 95320	N/A	EACH	N/A	1.24		
 Butyl Tube Sealant Item #: 95342	N/A	EACH	N/A	1.11		
 Multi-Rib Outside Closure	N/A	EACH	N/A	.05		
 R-Panel Outside Closure	N/A	EACH	N/A	.05		
 Multi-V Outside Closure	N/A	EACH	N/A	.05		

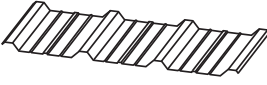
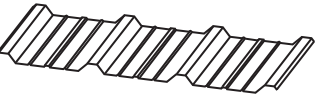
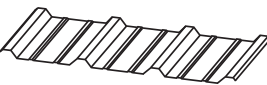
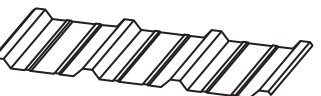
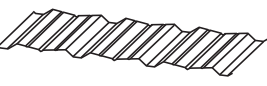
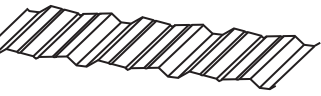

Accessories						
Product	GAUGE	UNIT OF MEASURE	LENGTH	WEIGHT	PRICING PER ITEM	Profiles & Dimensions
	N/A	EACH	N/A	.05		
Multi-Rib Inside Closure						
	N/A	EACH	N/A	.05		
R-Panel Inside Closure						
	N/A	EACH	N/A	.05		
Multi-V Inside Closure						
	N/A	EACH	N/A	.05		
Mini-Rib Closure						
	N/A	EACH	11'	17.55		
	N/A	EACH	12'	19.14		
Multi-Rib Fiberglass Panel	N/A	EACH	16'	25.52		
	N/A	EACH	11'	17.55		
R-Panel Fiberglass Panel						
	N/A	EACH	12'-6"	14.95		
Multi-V Fiberglass Panel						



MULTI-RIB/R-PANEL/MULTI-V/MINI-RIB

NOTES:

☆ MANUFACTURING LOCATIONS ● SERVICE CENTERS

★ MANUFACTURING AND SERVICE CENTER

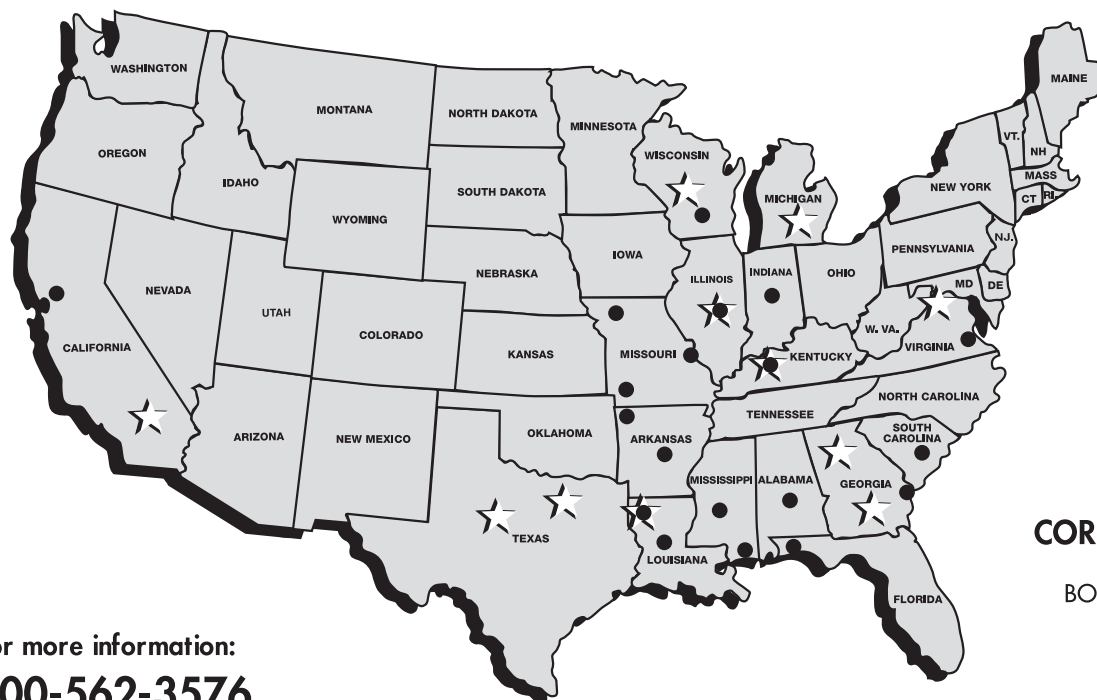

CORPORATE OFFICE
 1500 HAMILTON RD.
 BOSSIER CITY, LA 71111
 Ph: (800) 562-3576
 Fax: (318) 747-8029

For more information:
800-562-3576
www.mcelroymetal.com

MANUFACTURING LOCATIONS

BOSSIER CITY, LA
WINCHESTER, VA

CLINTON, IL
ADELANTO, CA

MARSHALL, MI
PEACHTREE CITY, GA

MERKEL, TX
MAUSTON, WI

LEWISPORT, KY

ASHBURN, GA

SUNNYVALE, TX

McELROY METAL
SERVICE
CENTER

5215 Leo St.
Alexandria, LA 71301

1500 Hamilton Rd.
Bossier City, LA 71111

3052 Yadkin
Chesapeake, VA 23323

10460 Revere Rd.
Clinton, IL 61727

3215 Highway 59
Diamond, MO 64840

409 Lovejoy Road
Ft. Walton Beach, FL 32548

14373 Creosote Rd., Bld. B
Gulfport, MS 39503

10504 E. 59th Street
Indianapolis, IN 46236

9435 U.S. Hwy 60 W.
Lewisport, KY 42351

3036 Progress Road
Madison, WI 53716

2506 Midpark Dr.
Montgomery, AL 36109

8304 Hwy. 70 E.
North Little Rock, AR 72117

613 North Bierdeman Rd.
Pearl, MS 39208

5300 83rd Street
Sacramento, CA 95826

1365 Dean Forest Rd.
Savannah, GA 31405

1801 S. Old Missouri Rd.
Springdale, AR 72764

165 North Outer Road West
Valley Park, MO 63088

1144 Silstar Rd.
West Columbia, SC 29170

30000 US Hwy. 69
Winston, MO 64689

Website: www.mcelroymetal.com • E-mail: marketing@mcelroymetal.com